

## REPLACEMENT PARTS

### MODEL IH6000

Part#	Description
6000.1	Fabric Cover
6000.2	Frame Rod
6000.3	Frame Hub
6000.4	Eyebolt & Strap
6000.5	Removable Window/Shade
IA2	Ice Anchor

To Order Parts, give Part No., Description and Qty Needed.

SHAPPELL CORP., 3562 W. Jefferson Hwy., Grand Ledge, MI 48837

Toll Free (888) 571-1144

### CONSUMER WARRANTY

SHAPPELL CORPORATION warrants its products against defects in material and workmanship for (1) YEAR from date of purchase. We will provide FREE repair or replacement, in whole or in part, at our option, for any product, found in our opinion to be defective. If return is required, freight must be prepaid. This warranty does not cover Freight Damage, Ordinary Wear and Tear, Abuse, Misuse or Altered Product.

### WINDOWS ARE NOT GUARANTEED AT TEMPERATURES BELOW -15 DEGREES FAHRENHEIT.

For warranty claim, send letter indicating product and explanation of defect plus dated proof of purchase to the SHAPPELL Corp., 3562 W. Jefferson Hwy, Grand Ledge, MI 48837.

5-26-10

# Shappell

# Ice House<sup>TM</sup> 6000

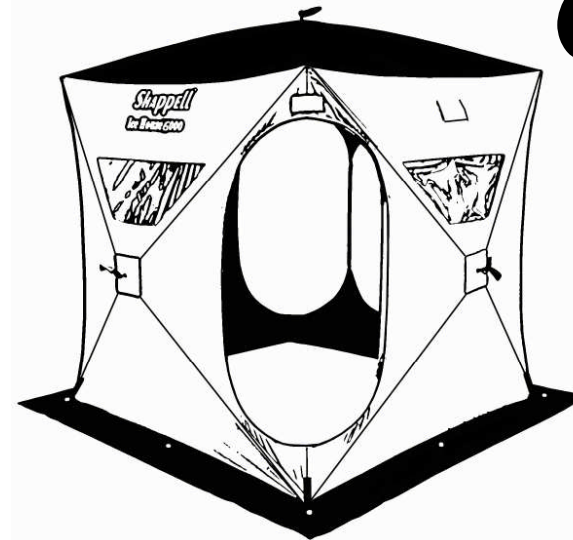

## IMPORTANT SAFETY INFORMATION



**WARNING:** Keep all Heat & Flame Sources away from the Shelter's Fabric Cover. The Fabric Cover is Fire Retardant, **it is not Fire Proof.** The use of any heat source can be extremely dangerous, both for Fire Hazard and Carbon Monoxide Emissions. The Shappell Corporation does not endorse the use of any Heater. It is the user's responsibility to follow the Instructions and Warnings provided by the Heater Manufacturer for the safe use of a particular Heater.



**CARBON MONOXIDE POISONING HAZARD:** This shelter must be ventilated if using an oxygen consuming heat source. **DO NOT PACK SNOW AROUND SHELTER** or in any way prevent fresh air from entering shelter. **Failure to Ventilate Shelter could create a Serious Health Hazard or Death.**

Window can not be made to withstand temperatures below  $-15^{\circ}$  F. (see warranty)

**MAINTENANCE:** After each use, set up shelter until fabric is completely dry. **Never leave shelter folded closed with a wet cover.**

**NOTICE:** It is normal for fabric to have some pinholes. This does not affect water repellency.

**READ SETUP & TAKEDOWN INSTRUCTIONS BEFORE USING SHELTER**

# Set Up

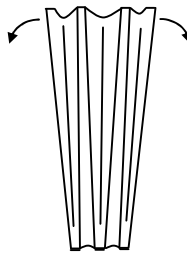

Fig. 1

1) Remove Tent from Bag and set Hub End on Ice. (Fig. 1)

2) Unfold Tent and screw in Ice Anchor at one corner eyelet. (Fig. 2)

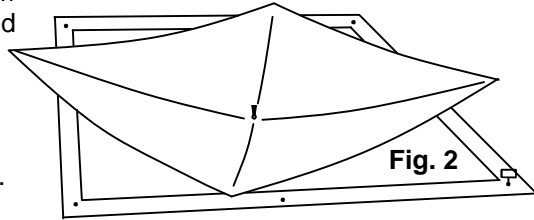

Fig. 2

3) Jerk up hard on Top Hub so it pops up. (Fig. 3)

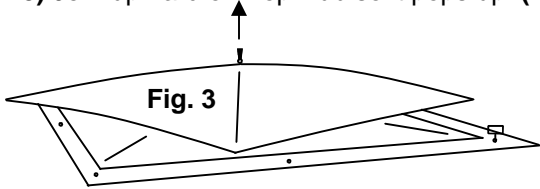

Fig. 3

4) Pull out Side Hub while pushing against Top Center. (Fig. 4)

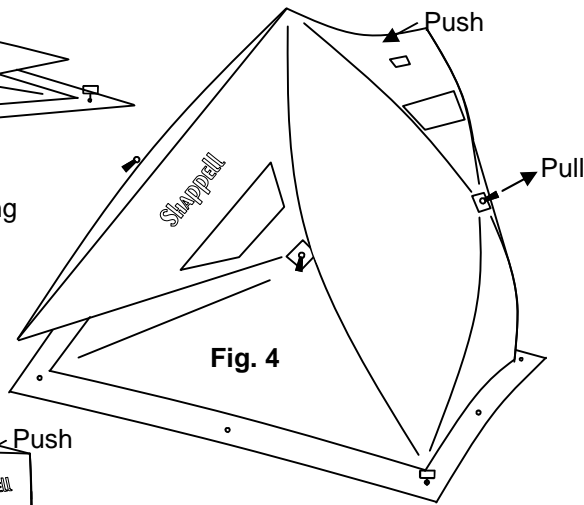

Fig. 4

5) Pull out remaining Side Hubs. (Fig. 5)

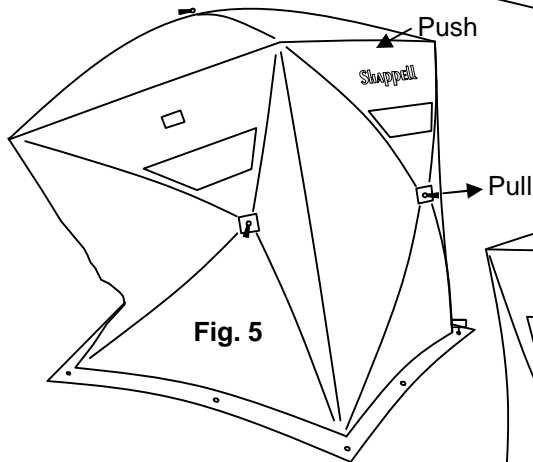

Fig. 5

6) Install remaining Ice Anchors as needed. (Fig. 6)

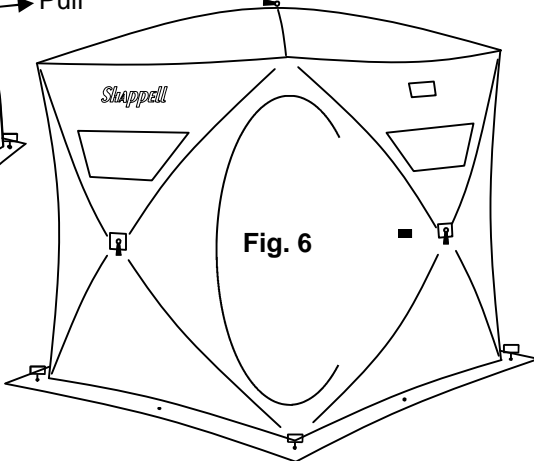

Fig. 6

# Take Down

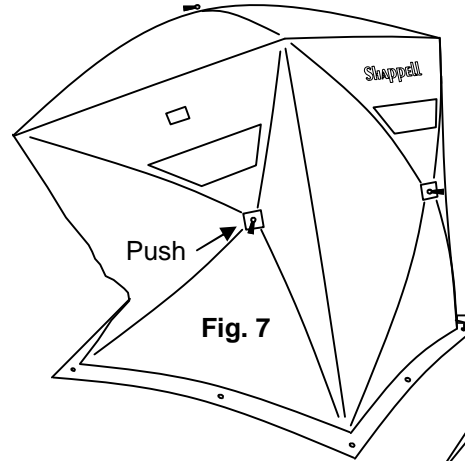

Fig. 7

1) Remove Ice Anchors, leaving one. Push in on Side Hub so it pops in. (Fig. 7)

2) Push remaining Side Hubs in. (Fig. 8)

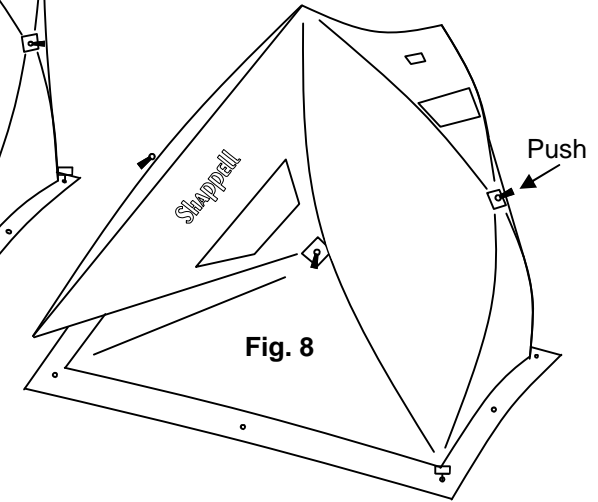

Fig. 8

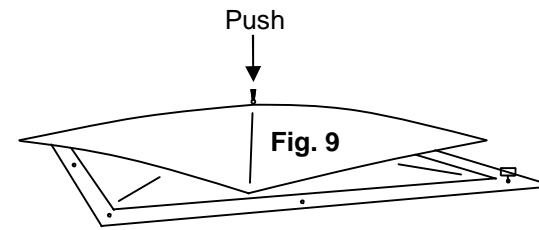

Fig. 9

3) Push Top Hub down. (Fig. 9)

4) Remove last Ice Anchor and Fold all corners up. (Fig. 10) & (Fig. 11)

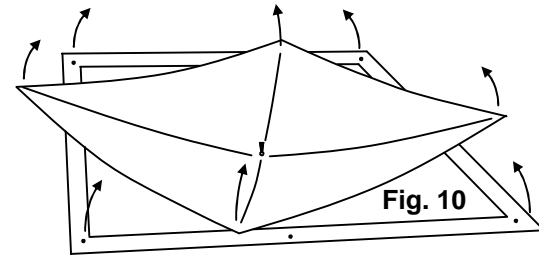

Fig. 10

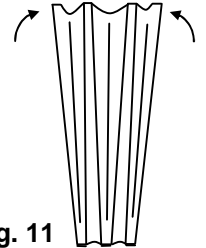

Fig. 11

5) Put tent into Bag with Hubs at the Bottom of Bag. (Fig. 12)

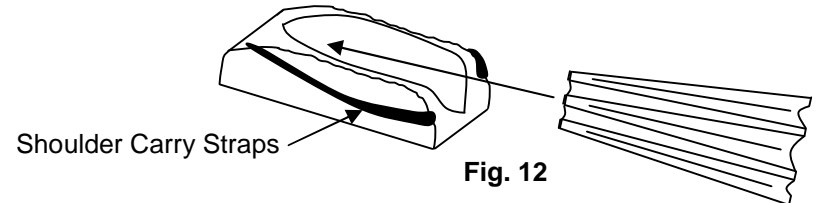

Fig. 12